

**ESCO**  
SCIENTIFIC



Model: SC2-4E\_G4



Model: SC2-4S\_G4

# Streamline® G4

## Class II Biological Safety Cabinets

*The Leading Energy-efficient, Quiet,  
and Ergonomic Biosafety Cabinet in the World*





## USB Port

- Export Data Logging
- Software Update
- Wired data transaction to BMS



## Centurion Touchscreen Controller

- 7" capacitive touchscreen, intuitive to use by user with gloves
- Displays key safety information graphically on one screen
- Built-in guide to use the cabinet and respond to situations
- Centered and angled down for easy reach & viewing
- Datalogger to assist diagnostics and send info to BMS



## One-Piece Interior Wall

- Double layer side walls with negative pressure
- Easy to reach service fixtures and outlets
- Large radius corner for easy cleaning

## Unique Side Walls

- Large corner radius for easy cleaning
- Glass hybrid wall is available (E-Series)
- Isocide™ coating Epoxy side wall is available (S-Series)
- Hole-free side glass for increased safety



## Removable Paper Catch

- Prolong the main filter life
- Easy to clean
- Optional pre-filter can be fitted



## Raised Ergonomic Arm Rest

- Helps prevent grille blocking
- Comfortable working posture



# ET, FEATURING ADVANCED TOUCHSCREEN CONTROLLER



Esco Streamline® G4 Class II Biosafety Cabinet Available in 4 feet and 6 feet models.

## Airflow Sensor

- Monitors real-time airflow for safety
- Alert the user if airflow is insufficient

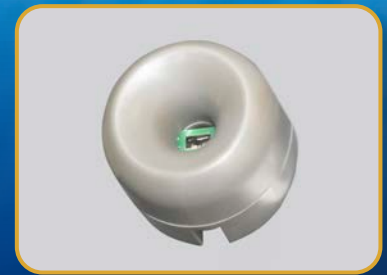

## Advanced Filtration System

- Creates ISO Class 3 work zone instead of industry-standard ISO Class 5
- Long 10 years filter life for lower operating cost

note: >99.999% at 0.1 to 0.3 micron, ULPA as per IEST-RP-CC001.3  
USA, >99.999% at MPPS, H14 as per EN 1822 EU



## Dynamic Chamber™

- Blower plenum and side walls are surrounded by negative pressure
- Prevents contaminants from escaping outside
- Steel plenum with Isocide™ coating, instead of flexible bag plenum, to prevent contamination leak

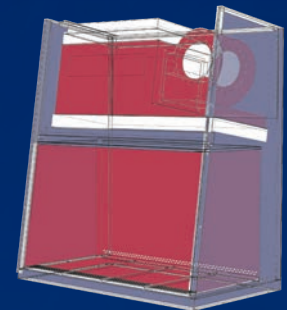

■ Positive pressure  
■ Negative pressure

## ISOCIDE™ Powder Coat

- Silver-ion impregnated powder coat
- Inhibits microbial growth to improve safety
- Prevents the plenum from becoming biohazard landfill



## Angled Sash

- 10° angled front to optimize user comfort, reduce glare and maximize reach into the work area

## Dished Work Tray

- Contains spillage
- Angled edge for easy cleaning
- Work tray holder underneath for seamless drain pan cleaning



## Standards Compliance and Certifications

Biosafety Cabinets	Air Quality	Filtration	Electrical Safety
EN 12469	ISO 14644.1, Class 3, Worldwide, US Fed Std 209E, Class 1 USA JIS B9920, Class 3, Japan BS 5295, Class 3, UK	EN-1822 (H14), Europe IEST-RP-CC001, USA	IEC/EN 61010-1

## Cabinet Filtration System

- Ambient air is pulled through front grille to create inflow, without going into the work surface. Inflow is joined by half of the downflow, to create front air curtain that is fine-tuned to create a large performance envelope. The combined air stream travels through the back air column towards the blower.
- Approximately 1/3 of the air in the common plenum is exhausted through the filter to the room. The remaining 2/3 of the air is passed through the downflow filter and into the work area as a vertical laminar flow air to create ISO Class 3 work surface and prevents cross contamination.
- Near the work surface, the downflow splits. About half goes to the front grille, and half goes to the rear grille. A small portion enters the side capture zones to prevent dead air corners (small blue arrows).
- The design was optimized to give large performance envelope, that provides operator and product protection at wide Inflow and Downflow variation from the Nominal point.

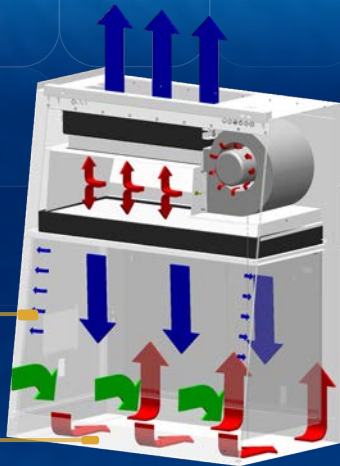

Dynamic air barrier, where inflow and downflow converge

Side capture zones

- Filtered air
- Unfiltered / potentially contaminated air
- Room air / Inflow air

## The Performance Envelope Concept

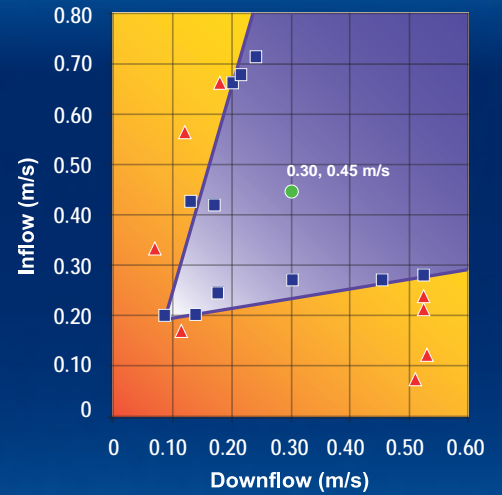

- Nominal Airflow
- Personnel / Product Protection
- Area of Personnel / Product Protection
- ▲ No Personnel / Product Protection
- Area of no Personnel / Product Protection

## Engineering Drawing

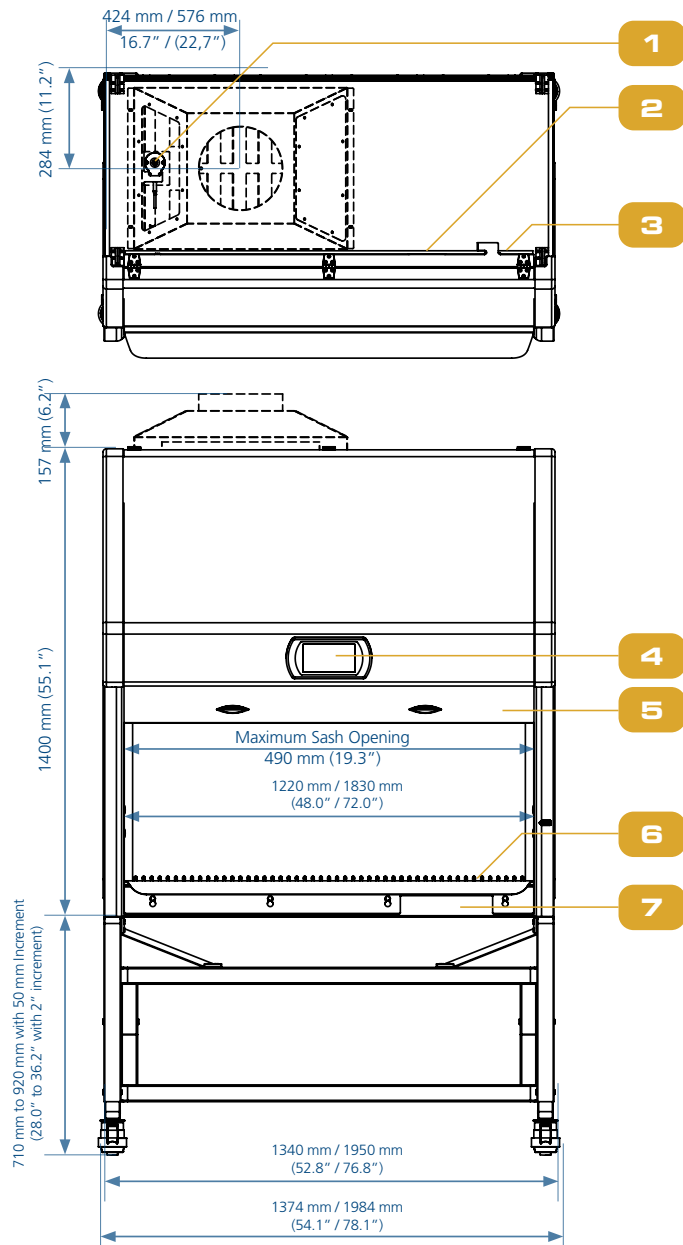

1. Exhaust Sensor
2. USB Port for data transfer
3. Power Inlet
4. Centurion 7" Touchscreen Control System
5. Tempered Glass - Sliding Sash Window
6. Stainless Steel Dished Work Tray
7. Data Plate
8. Electrical panel
9. Dimmable LED lamp
10. Provision for optional IV Bar
11. Stainless Steel Multi-piece Work Tray
12. Optional Exhaust Collar
13. Exhaust Filter
14. Downflow Filter
15. Optional UV Lamp
16. Electrical Outlet
17. Service Fixture Retrofit Kit Provision
18. Stainless Steel / Glass Side Walls

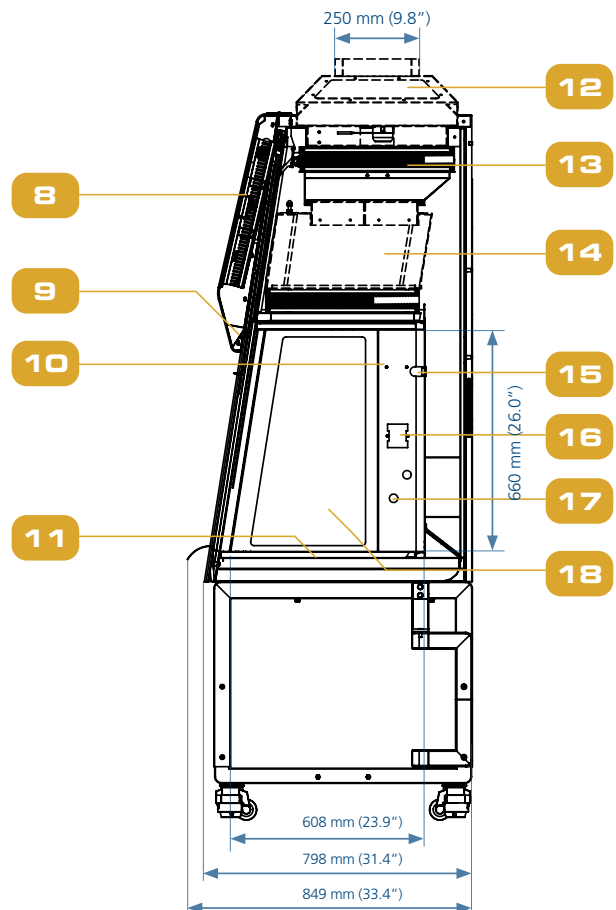

TECHNICAL SPECIFICATIONS		230 V, 50 HZ		230 V, 60 HZ	
S-Series Stainless Steel Side Walls		SC2-4S1 G4 2011575	SC2-6S1 G4 2011577	SC2-4S3 G4 2011576	SC2-6S3 G4 2011578
E-Series Tempered Glass Side Walls		SC2-4E1 G4 2011571	SC2-6E1 G4 2011573	SC2-4E3 G4 2011572	SC2-6E3 G4 2011574
Nominal Size		1.2 meter (4')	1.8 meter (6')	1.2 meter (4')	1.8 meter (6')
External Dimensions with armrest (W x D x H)		1340 x 850 x 1400 mm (52.8" x 33.5" x 55.1")	1950 x 850 x 1400 mm (76.8" x 33.5" x 55.1")	1340 x 850 x 1400 mm (52.8" x 33.5" x 55.1")	1950 x 850 x 1400 mm (76.8" x 33.5" x 55.1")
Gross Internal Dimensions (W x D x H)		1220 x 610 x 661 mm (48.0" x 24.0" x 26")	1830 x 610 x 661 mm (72.0" x 24.0" x 26")	1220 x 610 x 661 mm (48.0" x 24.0" x 26")	1830 x 610 x 661 mm (72.0" x 24.0" x 26")
Usable Work Area		0.55 m <sup>2</sup> (5.9ft <sup>2</sup> )	0.87 m <sup>2</sup> (9.3 ft <sup>2</sup> )	0.55 m <sup>2</sup> (5.9ft <sup>2</sup> )	0.87 m <sup>2</sup> (9.3 ft <sup>2</sup> )
Tested Opening		175 mm (6.9")			
Maximum Opening		490 mm (19.3")			
Average Inflow Velocity		0.45 m/s (90 fpm)			
Average Downflow Velocity		0.32 m/s (63 fpm)			
Airflow Volume	Inflow	96 cmh (56.5 cfm)	144 cmh (84.8 cfm)	96 cmh (56.5 cfm)	144 cmh (84.8 cfm)
	Downflow	815 cmh (480 cfm)	1223 (720 cfm)	815 cmh (480 cfm)	1223 (720 cfm)
	Total Airflow	911 cmh (536 cfm)	1367 cmh (805 cfm)	911 cmh (536 cfm)	1367 cmh (805 cfm)
Advanced Filtration Efficiency	Exhaust	>99.999% at 0.1 to 0.3 micron, ULPA as per IEST-RP-CC001.3 USA >99.999% at MPPS, H14 as per EN 1822 EU			
	Downflow				
Sound Emission per EN12469*		60.2 dBA	61.5 dBA	60.2 dBA	61.5 dBA
Light Intensity		more than 1000 lux			
Cabinet Construction	Main Body	1.2 mm (0.05") / 18 gauge EG steel with Isocide™ oven-baked epoxy-polyester anti-microbial powder coating			
	Work Zone	1.5 mm (0.06") / 16 gauge, stainless steel 304, 4B finish			
	Side Walls	S-Series: 1.5 mm (0.06") / 16 gauge, stainless steel 304, 4B finish E-Series: UV-absorbing tempered glass, 6 mm (0.2"), transparent			
	Sash Glass Material	6 mm thickness UV-absorbing Tempered Glass			
Electrical**	Cabinet Full Load Amps (FLA)	10 A			
	Heat Load (BTU)	894	1911	1126	2695
Nominal Power Consumption		262	560	330	790
Net Weight		255 kg (562 lbs)	338 kg (745 lbs)	255 kg (562 lbs)	338 kg (745 lbs)
Shipping Weight		323 kg (712 lbs)	430 kg (948 lbs)	323 kg (712 lbs)	430 kg (948 lbs)
Shipping Dimensions, Maximum (W x D x H)		1450 x 850 x 1950 mm (57.1" x 33.5" x 76.8")	2050 x 850 x 1950 mm (80.7" x 33.5" x 76.8")	1450 x 850 x 1950 mm (57.1" x 33.5" x 76.8")	2050 x 850 x 1950 mm (80.7" x 33.5" x 76.8")
Shipping Volume		2.5 m <sup>3</sup> (88.2 f <sup>3</sup> )	3.6 m <sup>3</sup> (127.1 f <sup>3</sup> )	2.5 m <sup>3</sup> (88.2 f <sup>3</sup> )	3.6 m <sup>3</sup> (127.1 f <sup>3</sup> )

Specifications are subject to change without notice.

\*Noise reading in open field condition / anechoic chamber. Noise reading in normal room varies by room size, layout, and background noise, but may reach roughly 3-4 dBA above these values.

\*\* Electrical power consumption is a measurement of new unit within nominal set point. Result may vary due to several independent variables.

## Options and Accessories

Model	SC2-4S1 G4 2011575	SC2-6S1 G4 2011577	SC2-4S3 G4 2011576	SC2-6S3 G4 2011578
	SC2-4E1 G4 2011571	SC2-6E1 G4 2011573	SC2-4E3 G4 2011572	SC2-6E3 G4 2011574
UV Lamp	UV-30A-L 5170255			
IV Bar	IV-1215 5170231	IV-1825 5170501	IV-1215 5170231	IV-1825 5170501
Support Stand w/ Castors wheel and levelling feet (28" and 36")	STA-4A0 5131341	STA-6A0 5131389	STA-4A0 5131341	STA-6A0 5131389
EU SF 20mm	Gas (5170410)   Air (5170502)   Water (5170458)   Vacuum (5170457)   Nitrogen (5170503)			
US SF – Universal – 22mm	SF-2U22 5170504			
Solenoid Gas Valve	SOLENOID VALVE FITTING 5075239			
Copper Piping	5170026			
Thimble Exhaust Collar	ECO-SC2-4FT G4 5171249	ECO-SC2-6FT G4 5171317	ECO-SC2-4FT G4 5171249	ECO-SC2-6FT G4 5171317
Anti-blowback Valve 10"	B2-ABBV1 (5170129) / ABBV-10S (5170354)			
Exhaust Damper	DAMPER 5170104			
Front Decon cover with VHP IN PORT	FRONT DECON COVER VHP IN PORT LA2LR2VA2AC2AR2-4-G4 5171323	FRONT DECON COVER VHP IN PORT LA2LR2VA2AC2AR2-6-G4 5171327	FRONT DECON COVER VHP IN PORT LA2LR2VA2AC2AR2-6-G4 5171327	FRONT DECON COVER W/ VHP IN PORT AC2-5-G4 5171325
Top Decon cover with VHP OUT PORT	TOP DECON COVER VHP OUT LA2LR2VA2AC2AR2-4-G4 5171324	TOP DECON COVER VHP OUT LA2LR2VA2AC2AR2-6-G4 5171328	TOP DECON COVER VHP OUT LA2LR2VA2AC2AR2-4-G4 5171324	TOP DECON COVER VHP OUT LA2LR2VA2AC2AR2-6-G4 5171328
Thimble Exhaust Collar with VHP OUT (1" diameter)	ECO-W/ VHP-OUT SC2-4 G4 5171387	ECO-W/ VHP-OUT SC2-6 G4 5171388	ECO-W/ VHP-OUT SC2-4 G4 5171387	ECO-W/ VHP-OUT SC2-6 G4 5171388
Arm Rest Padding	MEWREST 5170127			
Foot Rest	FT-REST 5170073			
IQOQ Protocol	Hardcopy 9010179 Softcopy 9010179-A			
FAT / SAT	RSR-020 / RSR-034			

## Accessories

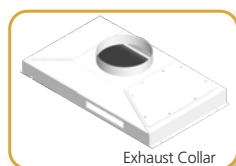

# ESCO

LIFESCIENCES GROUP

*Improving Lives through Science*

## ESCO SCIENTIFIC



- Animal Research Workstation
- Biological Safety Cabinet
- CO<sub>2</sub> Incubator
- Ducted Fume Hood
- Ductless Fume Hood
- Filtered Storage Cabinet
- Laboratory Centrifuge
- Laboratory Oven and Incubator
- Laboratory Refrigerator and Freezer
- Laboratory Shaker
- Laminar Flow Cabinet
- PCR Cabinet
- Powder Weighing Balance Enclosure
- Thermal Cycler
- Ultra-low Temperature Freezer

## ESCO MEDICAL



- Time-Lapse Incubator
- Benchtop Incubator
- ART Workstation
- CO<sub>2</sub> Incubator
- Anti-Vibration Table
- Gas Analyser

## ESCO Healthcare

"Discovery to Delivery"



ESCO  
PHARMA

ESCO  
TaPestle

ESCO  
VACCIXCELL

Pharmaceutical Manufacturing, Pharmacy Compounding, and Bioprocessing Tools

## ESCO ASTER



CRDMO Services

**ESCO LIFESCIENCES GROUP**  
42 LOCATIONS IN 21 COUNTRIES ALL OVER THE WORLD

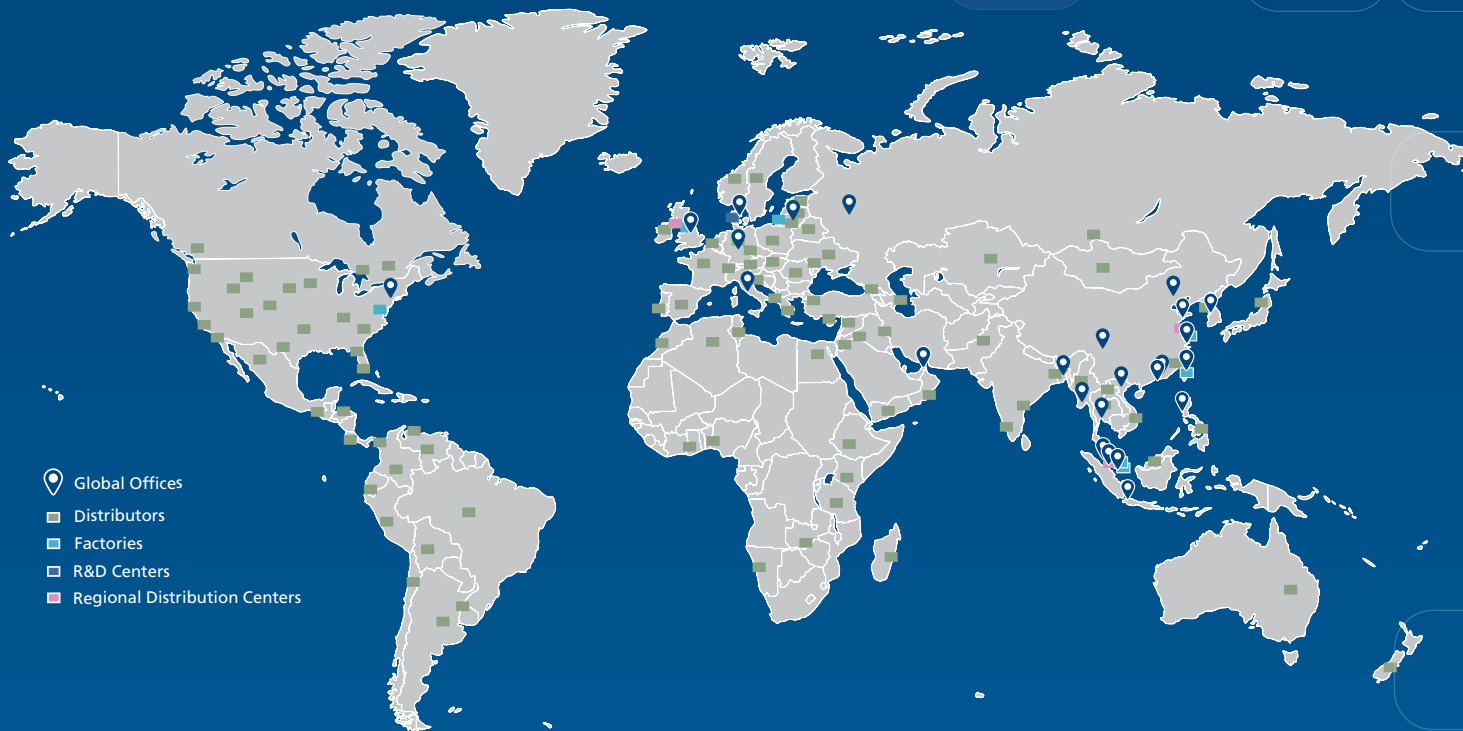

-  Global Offices
-  Distributors
-  Factories
-  R&D Centers
-  Regional Distribution Centers

*Follow us on social media, download our apps,  
and scan the QR code for more info.*



@EscoLifesciences @EscoLifesciences



@EscoLifesciences



@EscoLifesci



@Esco



@EscoLifesciences @EscoLifesciences



@EscoLifesciences



Esco Lifesciences



Esco Lifesciences

# ESCO<sup>®</sup>

LIFESCIENCES GROUP

Esco Micro Pte. Ltd. • 19 Changi South Street 1 • Singapore 486779  
Tel +65 6542 0833 • mail@escolifesciences.com  
www.escolifesciences.com

Esco GB Ltd. • Unit 2 R-Evolution @ Gateway 36, Kestrel Way Barnsley,  
S Yorks S70 5SZ • United Kingdom  
Tel: +1 215-441-9661 • Fax 484-698-7757 • egb.info@escoglobal.com  
www.escolifesciences.co.uk

**Esco Lifesciences Group Offices:** Bangladesh | China | Denmark | Germany | Hong Kong | India | Indonesia | Italy | Japan | Lithuania  
| Malaysia | Myanmar | Philippines | Russia | Singapore | South Africa | South Korea | Taiwan | Thailand | UAE | UK | USA | Vietnam

